

KUDOS

L Shaped Showerbath Screen With Handle

INSTALLATION INSTRUCTIONS

Please read these instructions before installing, as incorrect fitting will invalidate the guarantee. If you are unsure about these instructions please contact:
Customer Service Helpline: 01539 564040

TOOLS REQUIRED

Flat-headed screwdriver	Electric drill
Pozi-drive screwdriver	7mm masonry drill
Spirit level	4mm Allen key (supplied)
Tape measure	Silicone Sealant

IMPORTANT

Check appearance of bathscreen.

Any defects must be reported to Kudos Showers before assembly/ installation.

Claims for imperfections will only be accepted prior to assembly/ installation.

Ensure bath is level in **all** directions. Waterproof walls using ceramic tiles/ shower panels etc., **before** installing bathscreen

Care should be taken when drilling into walls to avoid hidden pipes or electrical cables

Any gap or crevice between the rim of the bath and finished walls must be filled with silicone sealant flush with the rim of the bath **before** installing bathscreen - see detail opposite

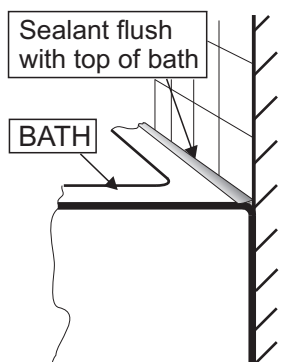

HANDING

HANDING THE SCREEN - this bathscreen is suitable for both left-hand and right-hand fitting, simply turn the glass panels around to suit your installation. Ensuring that the Lifeshield coating is always to the inside.

CLEANING

GENERAL - For frame work and fittings use only warm soapy water and damp cloth/ sponge on a regular basis. After cleaning please rinse with clean water to remove any residue.

Do not use abrasive scouring powders, chemicals or aerosol cleaners - these may result in damage to the surfaces, in particular, the plated component parts

See instruction below for glass cleaning advice.

LIFESHIELD

Your Kudos Product is pre-treated with Lifeshield on the inside glass surfaces only. While this makes cleaning the glass a lot easier and helps prevent the build up of harmful lime-scale and soap deposits the glass still needs to be maintained on a regular basis. We recommend the use of a detergent and aroma free glass cleaner (A 50/50 mix of white vinegar and water works well) Strong detergents and abrasives can damage the coating.

DO NOT use abrasive cleaners or abrasive scrubbing equipment for cleaning!!

DO use a squeegee to remove remaining droplets of water from glass after showering, any build up of residue can be removed easily using an appropriate cleaner and agitation from soft cleaning equipment

THESE INSTRUCTIONS ARE TO BE LEFT WITH THE USER

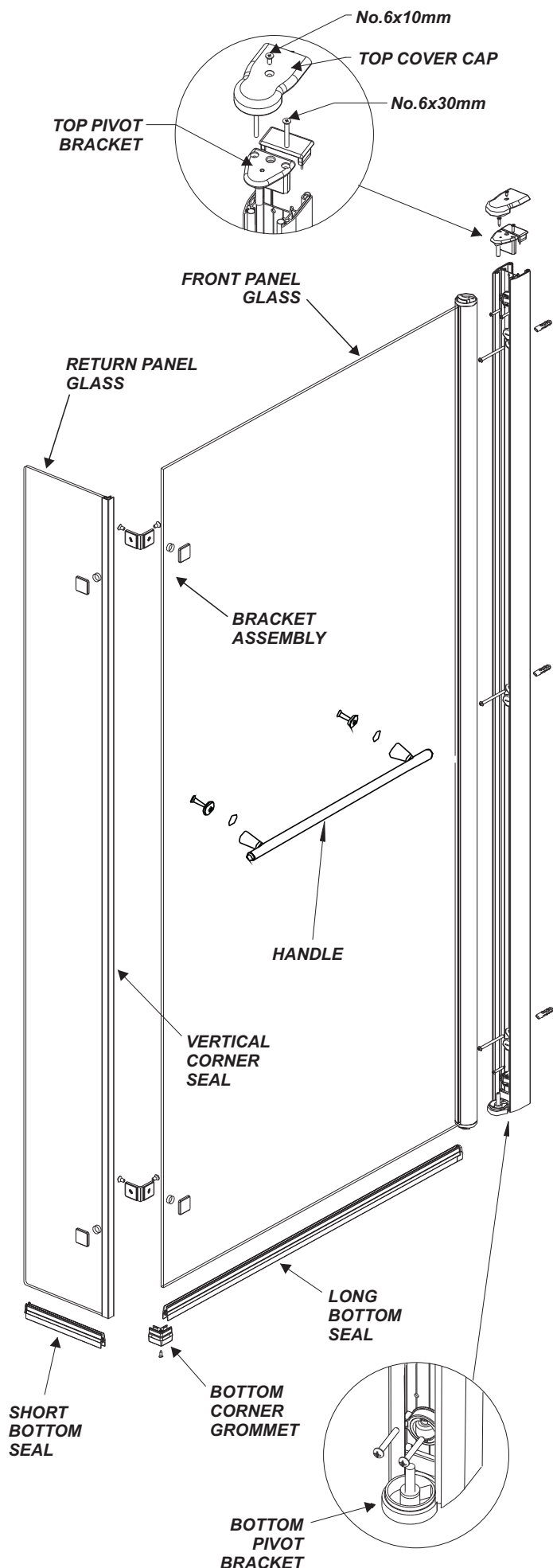

BATHSCREEN - EXPLODED VIEW

1 CHECK CONTENTS BY carefully removing bathscreen, bottom seals and fixing pack from packaging.

2 STAND PRODUCT UPRIGHT on protected floor surface (carpet or product packaging), to prevent damage.

TIP: Identify top of bathscreen by the top pivot bracket (with 2 screws visible).

3 REMOVE THE 2 SCREWS (put these aside for later) from the top pivot bracket and lift this out of the wallpost.
NB - THIS CAP SECURES THE GLASS TO THE WALLPOST AND YOU MUST HOLD THE GLASS WHEN REMOVING CAP.

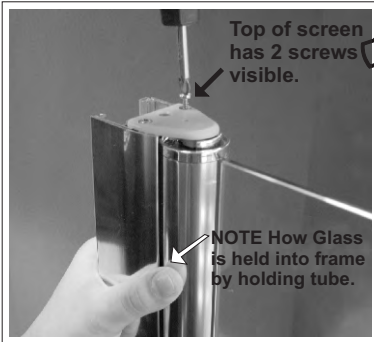

BE SURE TO HOLD TUBE INTO FRAME AS SHOWN WHEN REMOVING THIS CAP. THIS WILL PREVENT THE GLASS SLIDING OUT.

4 LIFT THE GLASS (with tube attached) out of the wallpost and put in a safe area.

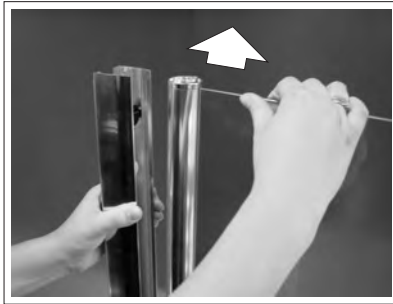

5 MARK POSITION OF WALLPOST using tape measure and pencil, mark 12mm from the outer rim of the bath inwards. This is the position of the outer face of the wallpost when set on the bath.

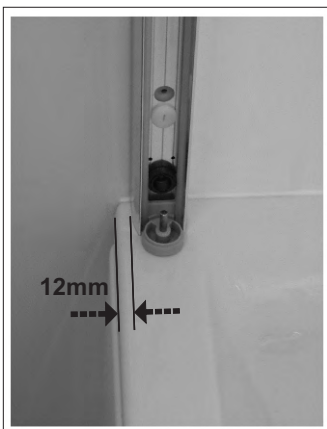

FOR LEFT HANDED BATH

Mark with pencil 12mm in from edge of the bath

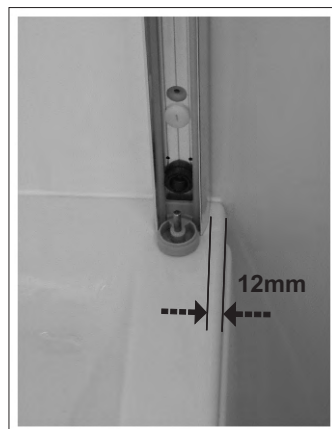

FOR RIGHT HANDED BATH

Mark with pencil 12mm in from edge of the bath

6 USING SPIRIT LEVEL held securely to the side of the wallpost, ensure the post is positioned vertically.

MARK POSITION OF HOLES onto the wall through the 3 'blue' plastic components located at the top, middle and bottom of the wallpost.
Remove wallpost from wall.



7 DRILL HOLES into wall using 7mm masonry drill and fit rawl plugs provided (or fixings suitable for the construction of your wall). Push wall plugs behind tiles to avoid cracking and silicone seal over each for watertight fit.

8 APPLY SILICONE sealant to underside of bottom pivot bracket.



9 FIX WALLPOST TO WALL using the 3 No.8 x 60mm panhead screws provided.
Do not overtighten these screws.

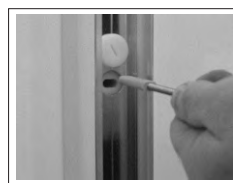

REMOVING BLUE INSERT SLEEVE IF NECESSARY

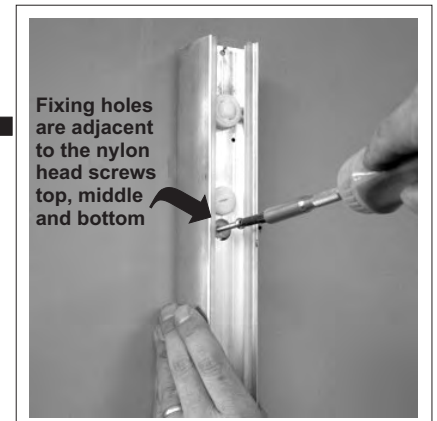

TIP: If the wallpost is not vertical, it is possible to adjust. Remove the wall fixing screws and use these to withdraw the blue insert sleeve which the screws pass through and discard the sleeve. This will leave a slotted hole.

Replace the screw, set the wallpost to vertical and re-tighten.

- 10 PLACE THE SPIRIT** level onto the front face of the wallpost and, if necessary, adjust until vertical by turning the top and/ or bottom plastic adjustment screws. **IMPORTANT - use the middle adjustment screw to ensure the wallpost is straight. This will also ensure that the seals are in full contact with the tube along their entire height when fitted.**
Note: max. 18mm adjustment in wallpost

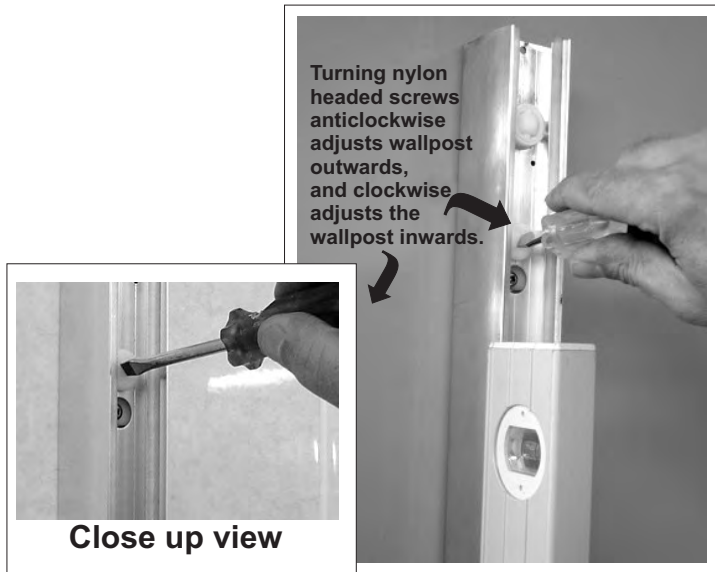

- 11 POSITION GLASS CAREFULLY** onto wallpost. The bottom of the tube has a hole which must slide over the pin in the bottom pivot bracket.

FIT TOP PIVOT BRACKET into wallpost and tube and hold this in position. Do not fit the two fixing screws yet.

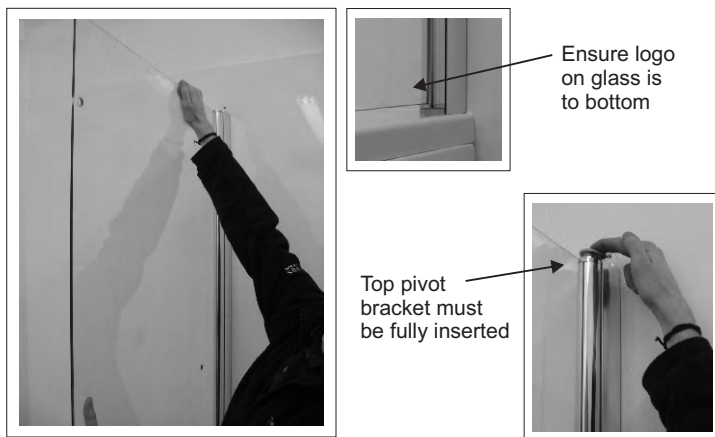

- 12 CHECK GAP** - Ensuring glass panel is running parallel with the bath edge check gap between bottom of glass panel and top of bath is equal along the entire length. If not, adjust the wallpost, as described in **stage 10**, until the gap is equal.

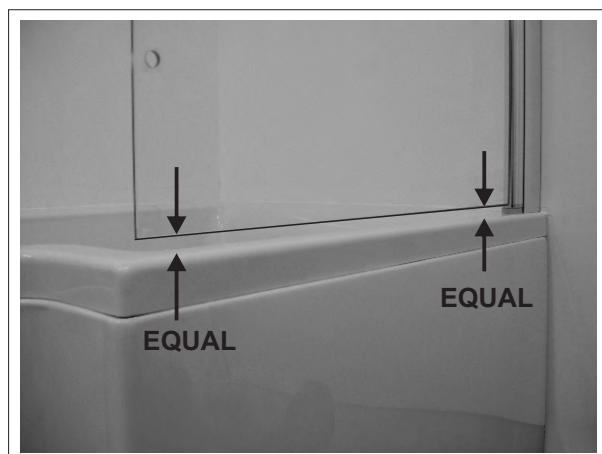

- 13 SECURE THE OUTER** wallpost to the inner wallpost using the pre-drilled holes and the 4 No.6 x 25mm panhead screws provided. **Ensure you progressively tighten each left and right pair so as not to pull the outer wallpost out of alignment.**

TIP Insert screws square to the wallpost to ensure they pick-up second hole in inner wallpost.
 You do not need to overtighten these screws.

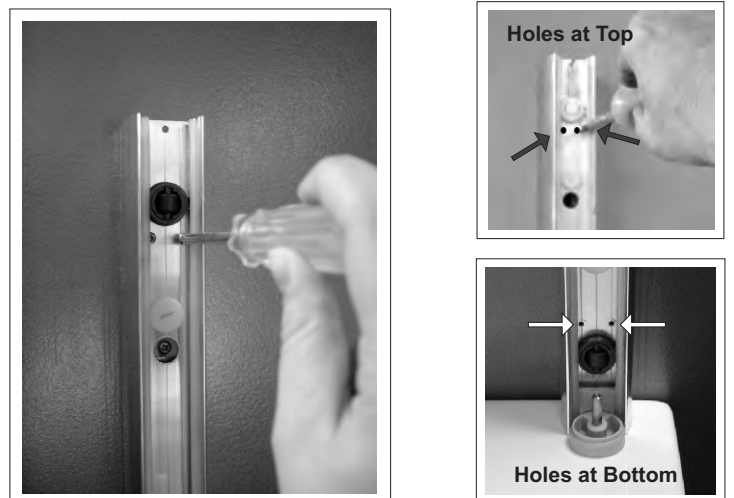

- 14 REFIT GLASS** and top pivot bracket and secure bracket with two screws removed in **stage 3**. It is important that these screws are correctly re-fitted into their screwports - failure to ensure this will result in damage to the product. **Do not overtighten these screws.**

TIP Use stepladders to help ensure screws are located correctly.

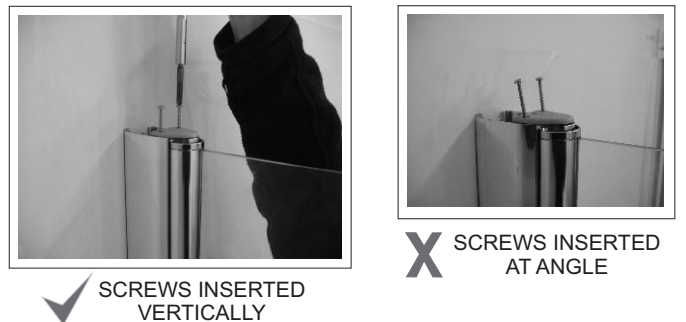

- 15 FIT VERTICAL CORNER SEAL** to return glass panel ensuring this lines up with bottom edge of glass.

TIP Wipe glass edge with clean damp cloth to ease fit.

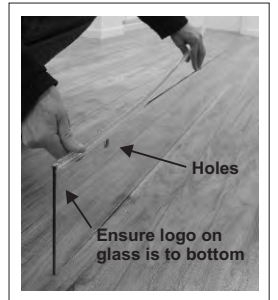
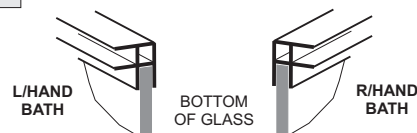

- 16 FIT RETURN GLASS PANEL** to front glass panel ensuring both glass panels are fully inserted into the corner seal along the full height.

IMPORTANT: Ensure the bottom edges of both glass panels line up with each other.

TIP Wipe glass edge with clean damp cloth to ease fit.



17 FIT CORNER BRACKETS

Fit plain protective washers to both inner 'L' shaped brackets and fit boss-type protective washers to the four outer square brackets. Using M5 x 10mm long screws provided, fit brackets to both panels through holes in glass. Ensure outer brackets are square to panel before tightening screws.



18 FIT HANDLE using 4mm allen key provided.

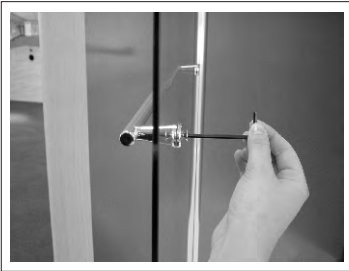

19 FIT LONG BOTTOM SEAL to front panel glass ensuring that the factory fitted end grommet is pushed fully up to the tube.



20 FIT BOTTOM CORNER GROMMET into end of bottom seal then push both up onto the glass and vertical corner seal.

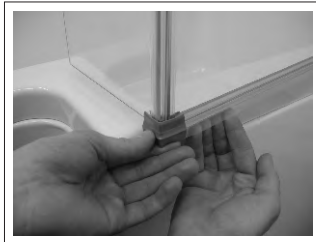

Please note corner grommet shown in grey for clarity purposes only

21 FIT SHORT BOTTOM SEAL into end of bottom corner grommet and onto glass.

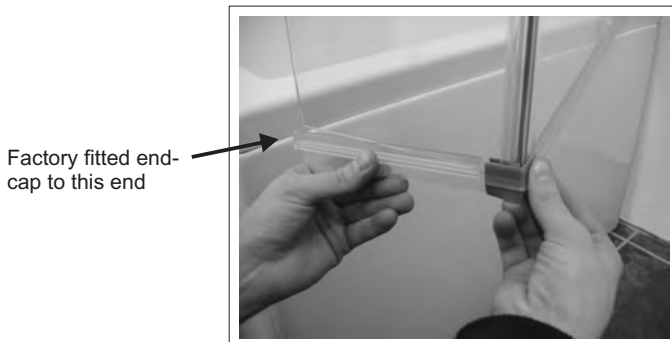

Factory fitted end-cap to this end

22 CHECK SEALS - Both bottom seals and corner grommet must be in contact with the bath top along their entire lengths. If not, ensure front panel glass is parallel with the bath edge and push seal(s) and corner grommet down, as necessary, to make full contact with the bath top.



23 SECURE GROMMET - fold screen INWARD into the bath and secure grommet in place by inserting the no.6x12mm long screw provided into hole on u/side of grommet.



TIP Hold the grommet still and finger-tighten the screw only.

Fold screen back parallel to bath edge and check that both seals and grommet are in full contact with bath top.

24 SILICONE SEAL - the wallpost to the wall and bath.

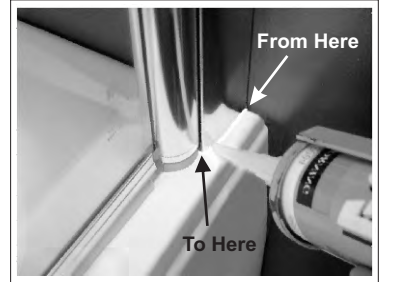
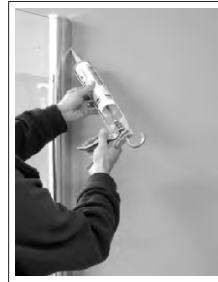

Seal down full height of wallpost to wall on INSIDE & OUTSIDE

Seal junction of wallpost to bath on **OUTSIDE ONLY** as shown.

DO NOT SEAL BOTTOM OF WALLPOST TO BATH ON INSIDE - water must be allowed to drain out of wallpost to inside.

25 SILICONE SEAL - the bottom corner grommet to bottom seals and vertical corner seal on inside and outside as shown and wipe clean excess silicone.

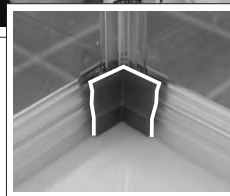
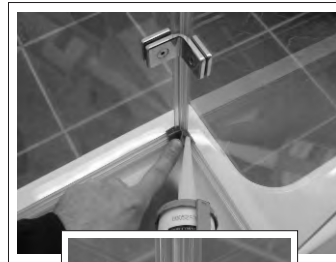

TIP Use clear/translucent silicone sealant for best results

DO NOT MOVE SCREEN & ALLOW 24 HOURS FOR SILICONE TO CURE BEFORE USE

Important - when installed correctly, we guarantee the screen will not leak under normal showering use, ie. when the shower head is in it's normal showering position. NB - Using the shower head to clean/rinse down the screen does not constitute normal showering use.