

# THE SAIL BATHSCREEN

## NO HANDLE

### Installation Instructions

Please read these instructions before installing, as incorrect fitting will invalidate the guarantee. If you are unsure about these instructions please contact Kudos Shower Products  
**Customer Service Helpline: 01539 564040**

#### TOOLS REQUIRED

- |                         |                   |
|-------------------------|-------------------|
| Flat-headed screwdriver | Electric drill    |
| Pozi-drive screwdriver  | 7mm masonry drill |
| Spirit level            | Tape measure      |

#### IMPORTANT

**Check appearance of bathscreen.**  
 Any defects must be reported to Kudos shower Products before assembly/ installation. Claims for imperfections will only be accepted prior to assembly/ installation

Ensure bath is level in **all** directions

Waterproof walls using ceramic tiles/ shower panels etc., **before** installing bathscreen

Care should be taken when drilling into walls to avoid hidden pipes or electrical cables

Any gap or crevice between the rim of the bath and finished walls must be filled with silicone sealant flush with the rim of the bath **before** installing bathscreen - see detail opposite

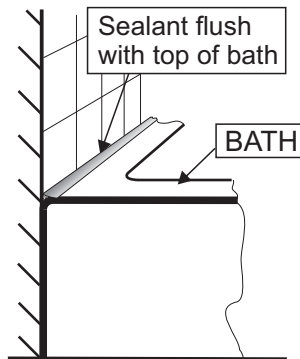

#### HANDING

**HANDING THE GLASS** - this bathscreen is suitable for both left-hand and right-hand fitting, simply turn the screen around to suit your installation.

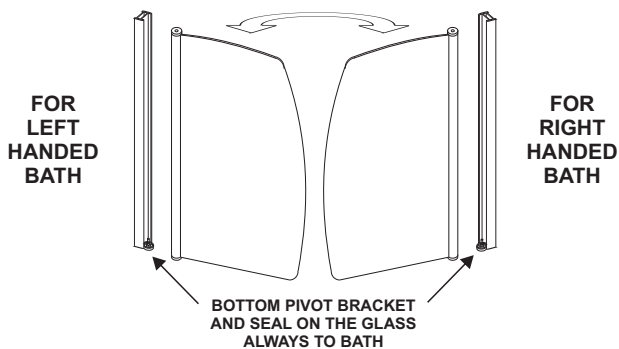

#### CLEANING

**GENERAL** - for frame work and fixings use only warm soapy water and damp cloth/ sponge on a regular basis. After cleaning please rinse with clean water to remove any residue. **See instruction opposite for glass cleaning advice.**

Do not use abrasive scouring powders, chemicals or aerosol cleaners - these may result in damage to the surfaces, in particular, the plated component parts

**THESE INSTRUCTIONS ARE TO BE LEFT WITH THE USER**

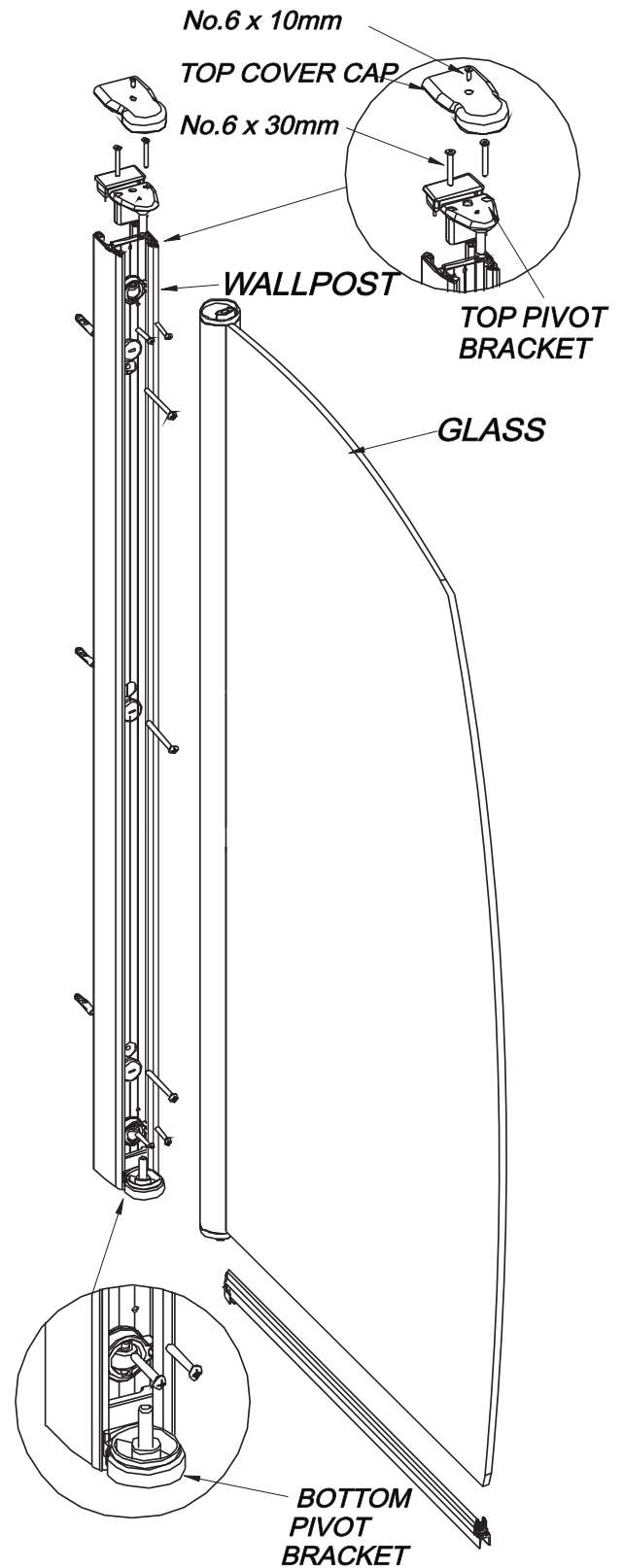

#### LIFE SHIELD

Your Kudos product is treated with Life Shield on the inside surface. Though this helps prevent the build up of lime-scale and soap deposits, the glass still needs regular maintenance. We recommend the use of a detergent and aroma free glass cleaner (A 50/50 mix of vinegar and water works well) Strong detergents and abrasives can damage the coating. After showering use a squeegee to remove droplets of water from the glass.

**1 CHECK CONTENTS BY** carefully removing bathscreen and fixing pack from packaging.

**2 STAND PRODUCT UPRIGHT** on protected floor surface (carpet or product packaging), to prevent damage.

*TIP: Identify top of bathscreen by the top pivot bracket (with 2 screws visible).*

**3 REMOVE THE 2 SCREWS** (put these aside for later) from the top pivot bracket and lift this out of the wallpost.  
*NB - THIS CAP SECURES THE GLASS TO THE WALLPOST AND YOU MUST HOLD THE GLASS WHEN REMOVING CAP.*

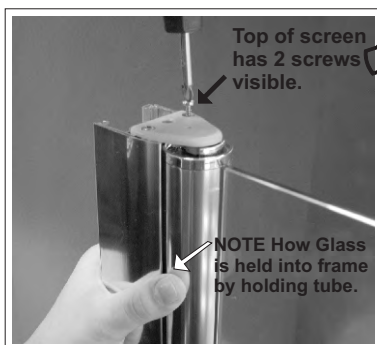

BE SURE TO HOLD TUBE INTO FRAME AS SHOWN WHEN REMOVING THIS CAP. THIS WILL PREVENT THE GLASS SLIDING OUT.

**4 LIFT THE GLASS** (with tube attached) out of the wallpost and put in a safe area.



**5 POSITION WALLPOST ONTO** bath so that when glass is fitted, the bottom seal is on **inside edge** of bath rim.



Inside edge of bath rim

LEFT-HAND FITTING

RIGHT-HAND FITTING

## 6 SPECIAL NOTE

It is particularly important to position the bathscreen on the inside edge for the following reasons:

**a.** To assist in water drainage off the screen and into the bath.

**b.** For baths where the inside edge of the rim is higher than that of the outside edge. (We are unable to guarantee the screen will not leak on baths with a rim of this sort).

**7 USING SPIRIT LEVEL** held securely to the side of the wallpost, ensure the post is positioned vertically.



**8 MARK POSITION OF HOLES** onto the wall through the 3 'blue' plastic components located at the top, middle and bottom of the wallpost.  
Remove wallpost from wall.



**9 DRILL HOLES** into wall using 7mm masonry drill and fit rawl plugs provided (or fixings suitable for the construction of your wall). Push wall plugs behind tiles to avoid cracking and silicone seal over each for watertight fit.

- 10** **APPLY SILICONE** sealant to underside of bottom pivot bracket.



- 11** **FIX WALLPOST TO WALL** using the 3 No.8 x 60mm panhead screws provided. Do not overtighten these screws.

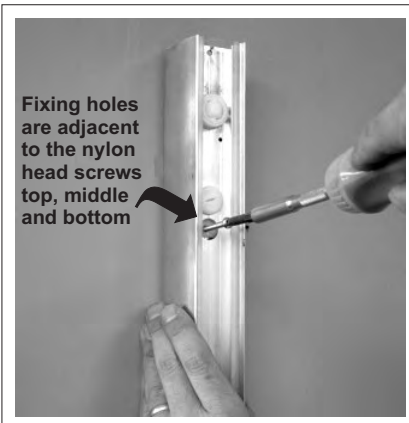
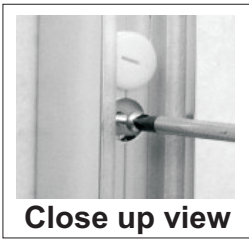

- TIP** *If the wallpost is not vertical, it is possible to adjust. Remove the wall fixing screws and use these to withdraw the blue insert sleeve which the screws pass through and discard the sleeve. This will leave a slotted hole.*

*Replace the screw, set the wallpost to vertical and re-tighten.*

- 12** **PLACE THE SPIRIT** level onto the front face of the wallpost and, if necessary, adjust until vertical by turning the top and/ or bottom plastic adjustment screws.

**IMPORTANT - use the middle adjustment screw to ensure the wallpost is straight. This will also ensure that the seals are in full contact with the tube along their entire height.**

*Note: max. 18mm adjustment in wallpost*

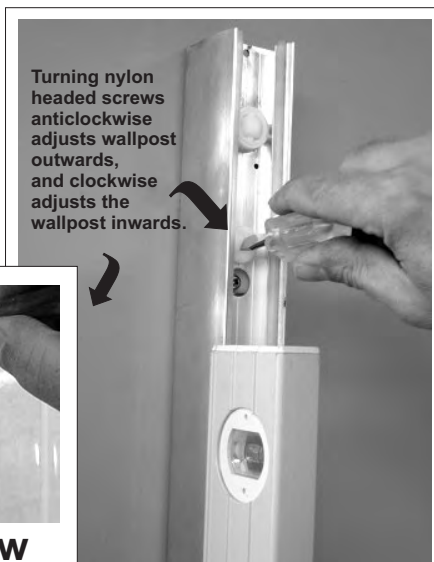

- 13** **FIT BOTTOM SEAL** to glass, sliding rigid legs over the bottom edge of glass. Ensure end of gasket with soft clear PVC plug is **FIRMLY** against the tube. Then insert fingers into soft legs of seal and press firmly onto glass.

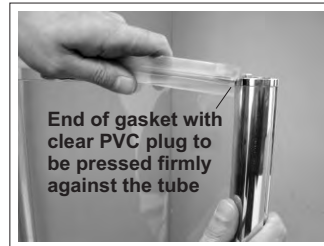

- 14** **FIT TOP PIVOT** bracket into wallpost and tube and hold this in position. Do not fit the two fixing screws yet.



- 15** **POSITION GLASS CAREFULLY** onto wallpost. The bottom of the tube has a hole which must slide over the pin in the bottom pivot bracket.

**NB - do not release your grip on the glass until you have completed stage 20, which secures the glass in position.**

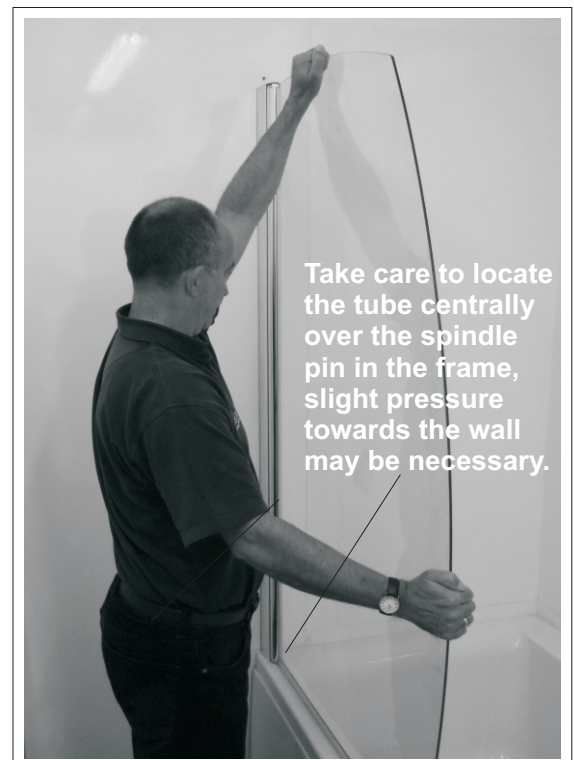

- 16** **TAKING CARE** to hold top pivot bracket in place, swivel the screen back and forth to test the sliding action of the seal on the rim of the bath. The ideal is that the seal should lightly sweep on the surface of the bath rim.

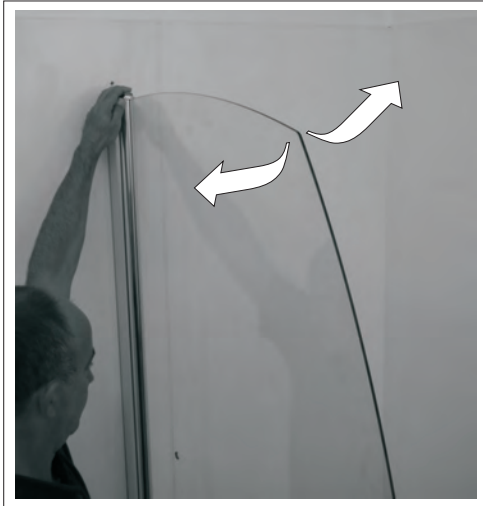

IF THE SEAL IS NOT TOUCHING LIGHTLY AND EVENLY PLEASE FOLLOW THE NEXT TWO STAGES

- 17** IF THE SEAL touches too firmly at the end furthest from the wall, remove the glass and turn the plastic adjustment screw in the top of the wallpost clockwise to angle the post back at the top. If top screw cannot turn clockwise, turn the bottom plastic screw anti-clockwise to angle post out at bottom.

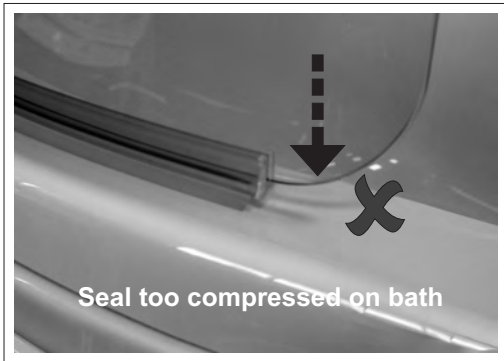

- 18** IF THE SEAL is not touching the bath rim at the end furthest from the wall, remove the glass and turn the plastic adjustment screw in the top of the wallpost anti-clockwise to angle the post out at the top. If top screw cannot turn anti-clockwise, turn the bottom plastic screw in wallpost clockwise to angle the post in at bottom.

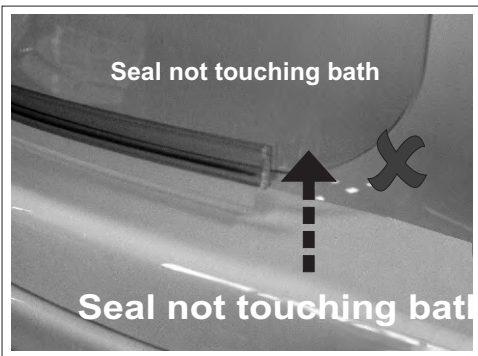

IF NECESSARY, REPEAT ABOVE TWO STAGES UNTIL AN EVEN LIGHT PRESSURE OF THE SEAL ON THE BATH IS ACHIEVED

- 19** **SECURE THE OUTER** wallpost to the inner wallpost using the pre-drilled holes and the 4 No.6 x 25mm panhead screws provided. **Ensure you progressively tighten each left and right pair so as not to pull the outer wallpost out of alignment.**

**TIP** Insert screws square to the wallpost to ensure they pick-up second hole in inner wallpost.

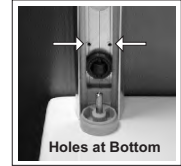
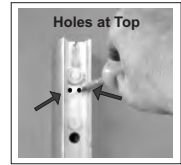

- 20** **REFIT GLASS** and top pivot bracket and secure bracket with two screws removed in stage 3. **It is important that these screws are correctly re-fitted into their screwports - failure to ensure this will result in damage to the product.**



- 21** **INSERT COVER CAP** to inner wallpost (two small pins away from wall) and top cover cap, which is fixed using the No.6 x 10mm csk screw provided.



- 22** If there is any gaps between the bottom seal and the top of the bath, then simply pull the seal down off the glass to close the gap.

- 22** **SILICONE SEAL** the bathscreen to the wall and bath.

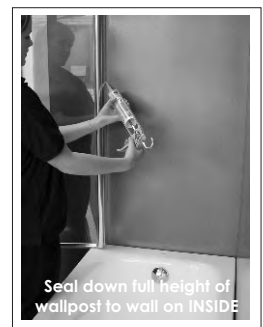
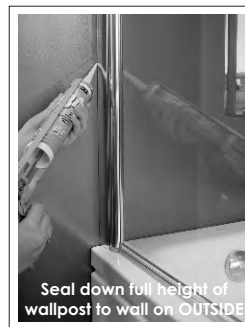

Seal junction of wallpost to bath on OUTSIDE ONLY as shown.

DO NOT SEAL BOTTOM OF WALLPOST TO BATH ON INSIDE- water must be allowed to drain out of wallpost to inside.

ALLOW 24 HOURS FOR SILICONE TO CURE BEFORE USE